

m o o o i[®]



Zio Lounge Chair

Lean back, close your eyes, relax your arms on the smooth armrests and grant yourself the time to drift your imagination away, beyond your surroundings, into the street, beyond the starry night. Living your fantasies is easy while cosily sitting in the solid softness of Marcel Wanders' Zio lounge chair!â

Designer

Marcel Wanders

Year of design

2013

Material

Solid oak frame

colours



Wood Stained
Cinnamon



Wood Stained
White Washed

Zio lounge chair, dining chair, dining table and coffee tables are also available in a composition of Cinnamon and White Washed stained oak.



Composition



Composition



Composition

packaging

Zio Lounge Chair

H 86 cm | 33,9"
W 83 cm | 32,7"
D 83 cm | 32,7"

Colli 1/1

With packaging:
15 KG | 33,1 lb

Zio Footstool

H 41 cm | 16,1"
W 59 cm | 23,2"
D 59 cm | 23,2"

Colli 1/1

With packaging:
10 KG | 22 lb

cleaning instructions

Moooi recommends using a good furniture polish and a soft cloth. Apply generously in layers to the surface and use the cloth to shine. Do not use abrasive fabrics, gently remove tough stains with warm water and a trusted multi-surface cleaner.

upholstery categories

Tartanic
Macchedil Sottile
Macchedil Grezzo
Oray
Manga
Faux

Bouclé
Jacquard Andaz
Jacquard Fresco
Jacquard Old Blue
Arredo Leather
Cervino Leather

Tartanic

composition

64% VI / 27% CO / 9% PA



Macchedil, Sottile

composition

49% vi, 24% pl, 21% li, 6% co

abrasion

30.000 martindale

lightfastness 4

firetest

FR BS5852 0/1

EN1021 I&2



Macchedil Sottile
Black indigo



Macchedil Sottile
Pinkish



Macchedil Sottile
Off white



Macchedil Sottile
Light grey



Macchedil Sottile
Light brown



Macchedil Sottile
Grey grey



Macchedil Sottile
Anthracite



Macchedil Sottile
Blue grey



Macchedil Sottile
Cappucino



Macchedil Sottile
Deep blue

Macchedil, Grezzo

composition

47% co, 20% vi, 18% pi, 8% li, 5% pc, 2% af

abrasion

18.000 martindale

lightfastness 4

firetest

FR BS5852 0/1

EN1021 1&2



Macchedil Grezzo
Black indigo



Macchedil Grezzo
Pinkish

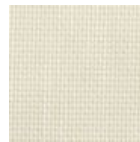

Macchedil Grezzo
Offwhite



Macchedil Grezzo
Light grey



Macchedil Grezzo
Light brown

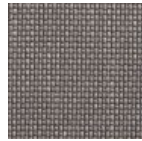

Macchedil Grezzo
Grey grey

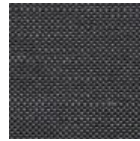

Macchedil Grezzo
Anthracite



Macchedil Grezzo
Blue grey



Macchedil Grezzo
Cappuchino



Macchedil Grezzo
Deepblue

Oray

composition

8% co, 38% vi, 15% pl, 39% li

abrasion

25.000 martindale

lightfastness 4

firetest

FR BS5852 0/1

EN1021 I&2



Oray
Cream



Oray
Sand



Oray
Rock



Oray
Mineral



Oray
Gravel

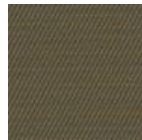

Oray
Dark Gull



Oray
Copper

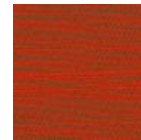

Oray
Rust



Oray
Flamboyant



Oray
Oil

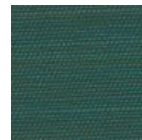

Oray
Aqua

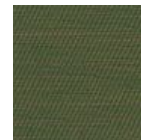

Oray
Peyote



Oray
Ocean



Oray
Metal



Oray
Griffin

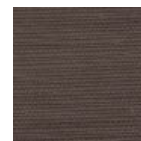

Oray
Dusk



Oray
Chestnut

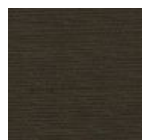

Oray
Dark



Oray
Indigo



Oray
Ochre

Faux

composition

100% pl

abrasion

50.000 martindale

lightfastness 4

firetest

FR BS5852 0/1

EN1021 I&2



Faux
Black

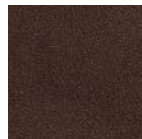

Faux
Brown

Bouclé

composition

43% co, 28% pan, 14% pa, 12% vi, 3% pl

abrasion

20.000> martindale

lightfastness 4

firetest

FR BS5852 0/1

EN1021 I&2

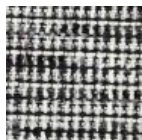

Bouclé
Black white

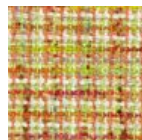

Bouclé
Rainbow



Bouclé
Brown

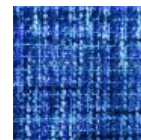

Bouclé
Blue

Jacquard andaz

composition:

34% cotton - 30% viscose - 24% linen - 12% polyamide

abrasion:

25000 martindale

firetest:

BS 5852 : Part 1 : 1979

BS EN 1021 1&2



Jacquard
Andaz

Jacquard Old Black & Blue

composition

52% vi, 38% co, 10% li

abrasion

20.000> martindale

firetest

FR BS5852 0/1

EN1021 1&2



Jacquard
Old Blue

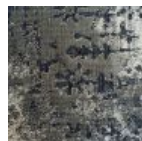

Jacquard
Old Black

Jaquard Fresco

composition

40% vi ,36% co,14% pl, 10% li

abrasion

20.000> martindale

firetest

FR BS5852 0/1

EN1021 1&2



Jaquard
Fresco

Arredo Leather

composition

100% semi aniline leather

firetest

FR BS5852 0/1

EN1021 1&2

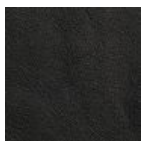

Arredo Leather
Black

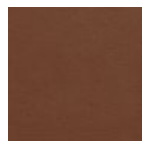

Arredo Leather
Brown



Arredo Leather
White

dimensions

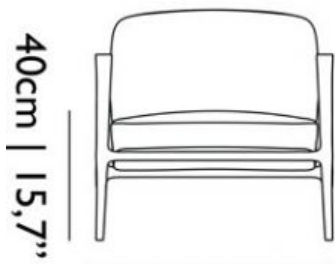
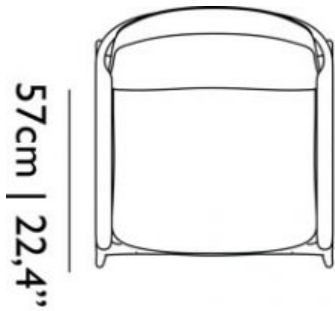

77cm | 30,3"



85cm | 33,5"

