

---

# Michel Effe

SOFAS

*Antonio Citterio*



## Description

With Michel Effe an important chapter is added to the successful story that started with Michel, the first modular sofa from the series. Some of the characteristics are unaltered, such as the two depths, but it is more essential than its predecessors. It reveals a new design thanks to a simplification of the seat with a single cushion. It is thinner, but not less comfortable. Everything superfluous has been eliminated.

---

## Technical information

### Back and armrest internal frame:

tubular steel and steel profiles

### Back and armrest internal frame upholstery:

Bayfit® (Bayer®) flexible cold shaped polyurethane foam, polyester fibre, polyester fibre cover

### Seat internal frame:

painted tubular steel and steel profiles, multilayered wood panel, shaped polyurethane

### Seat cushion upholstery:

shaped polyurethane of different density, sterilized down, polyester fibre cover

### Back cushion (MF65C-MF50C):

upholstery : down feather + polyurethane section, typology : box style

### Back cushion with roller (MF65CP-MF50CP):

upholstery : down feather + polyurethane section + polyester fibre, typology : box style + roller

### Support frame:

painted black chrome, pewter painted, bronzed nickel painted or bright brushed die-cast aluminium and extrusions

### Ferrules:

thermoplastic material

### Cover:

fabric or leather

# Technical drawings

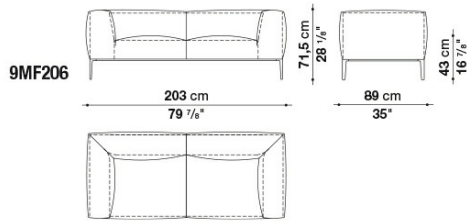

9MF206

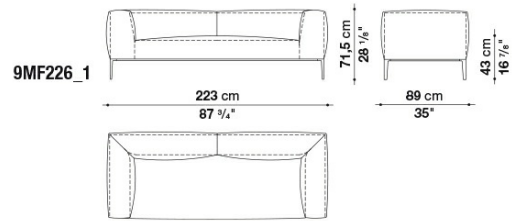

9MF226\_1

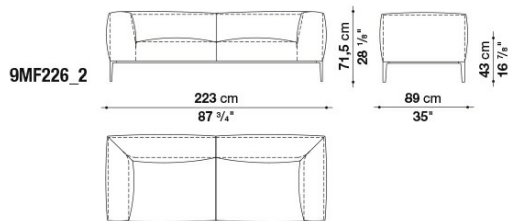

9MF226\_2

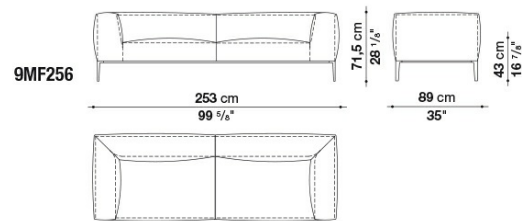

9MF256

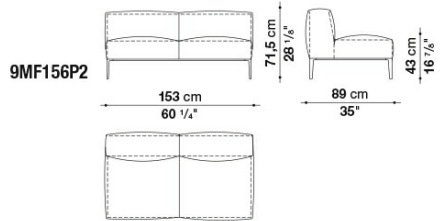

9MF156P2

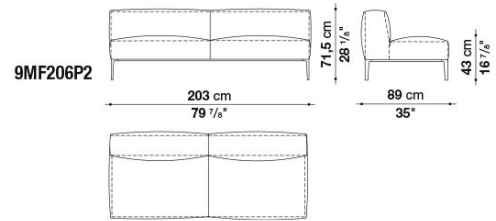

9MF206P2

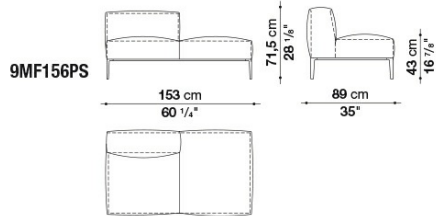

9MF156PS

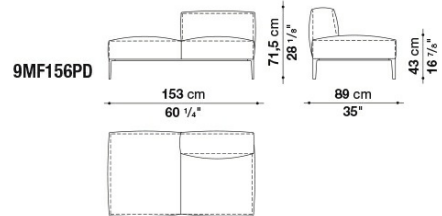

9MF156PD

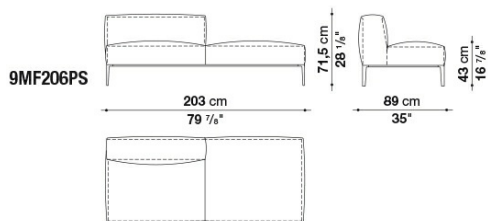

9MF206PS

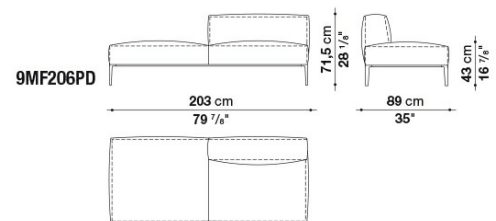

9MF206PD

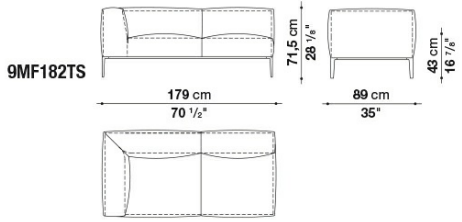

9MF182TS

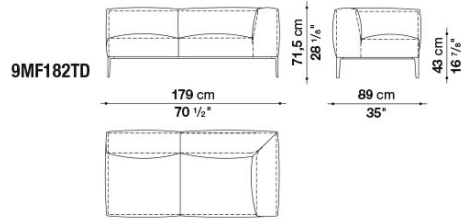

9MF182TD

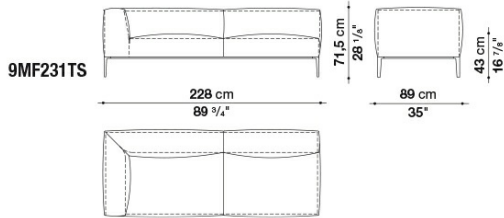

9MF231TS

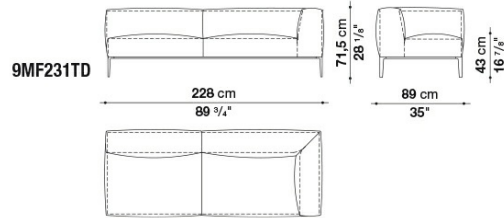

9MF231TD

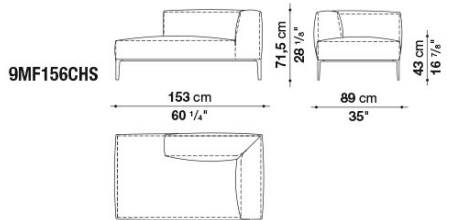

9MF156CHS

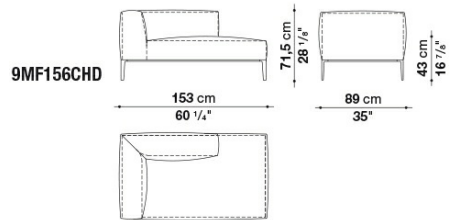

9MF156CHD

9MF231CHS

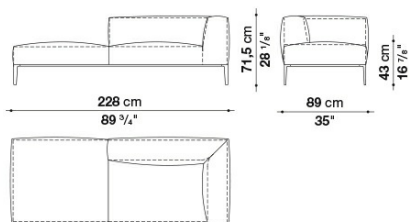

9MF231CHS

9MF231CHD

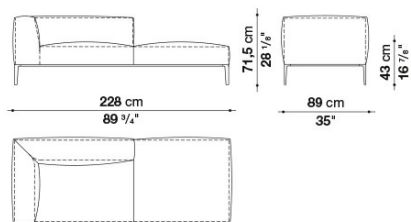

9MF231CHD

9MF91PQ

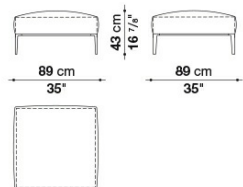

9MF91PQ

9MF156P

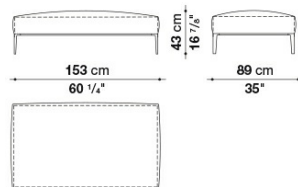

9MF156P

MF206

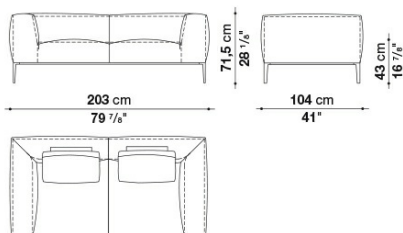

MF206

MF226\_1

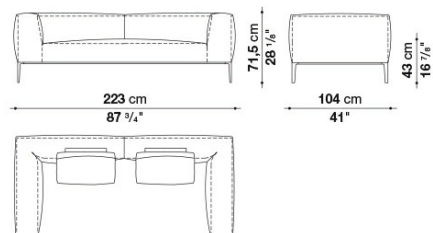

MF226\_1

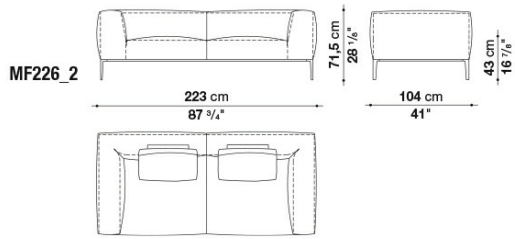

MF226\_2

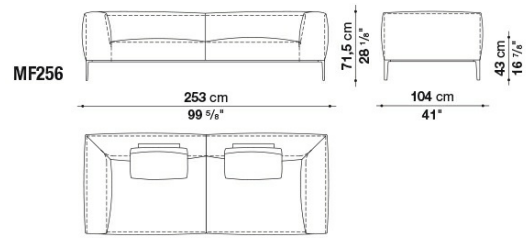

MF256

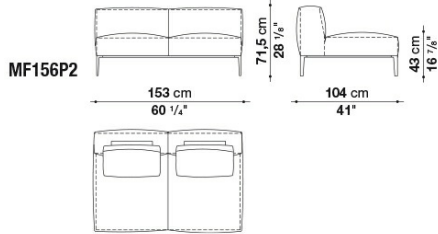

MF156P2

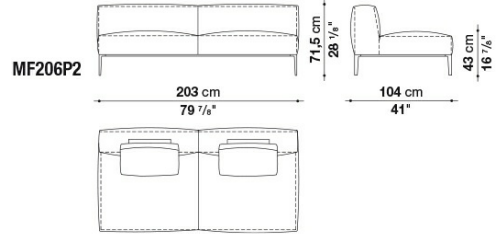

MF206P2

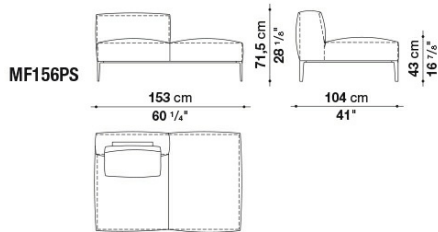

MF156PS

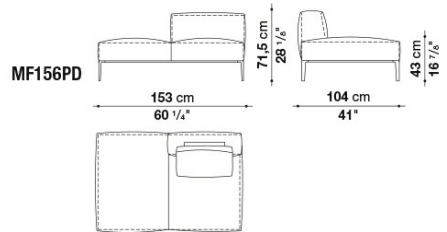

MF156PD

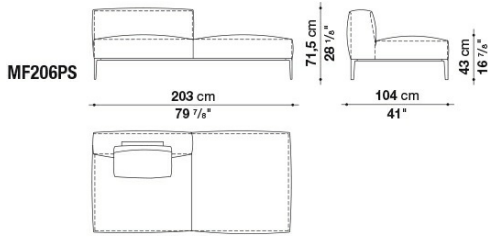

MF206PS

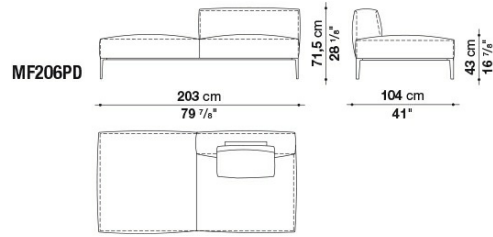

MF206PD

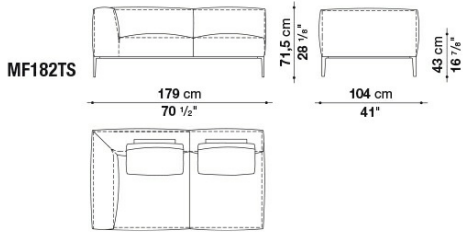

MF182TS

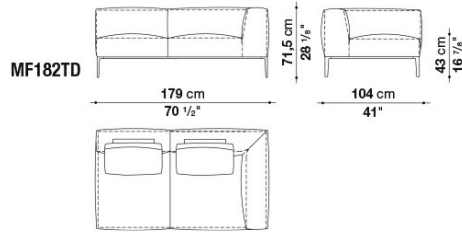

MF182TD

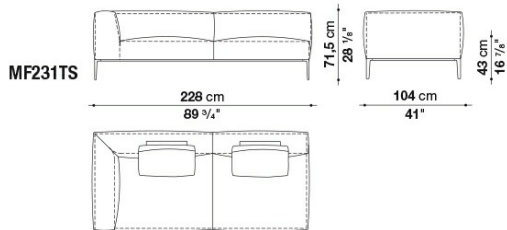

MF231TS

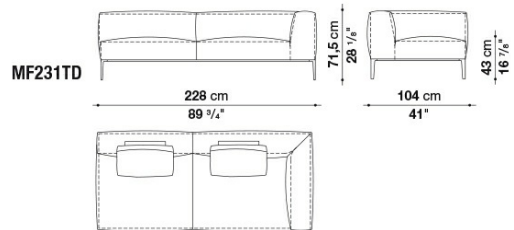

MF231TD



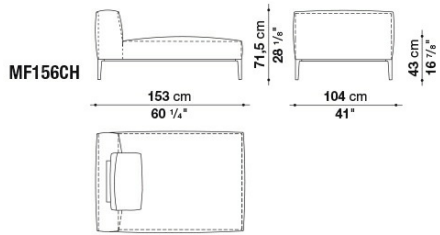

MF156CH

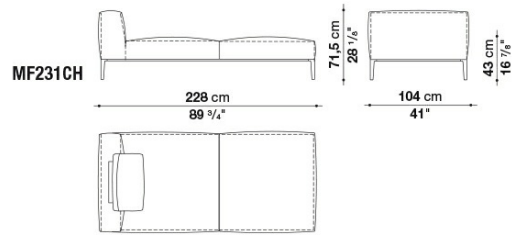

MF231CH

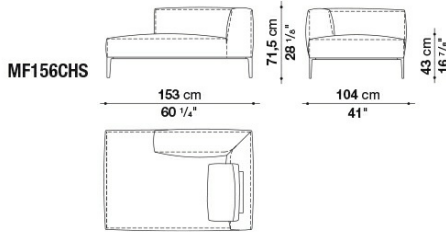

MF156CHS

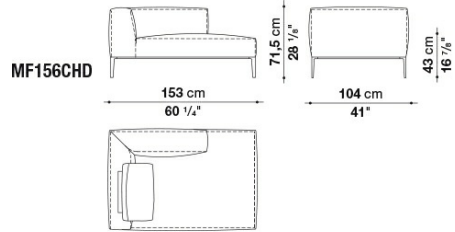

MF156CHD

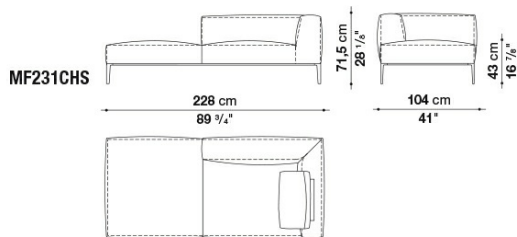

MF231CHS

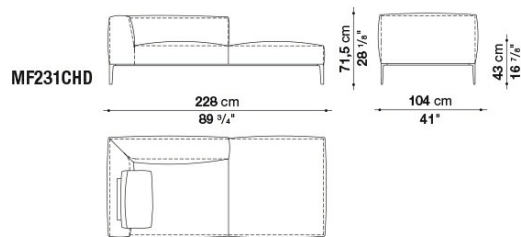

MF231CHD

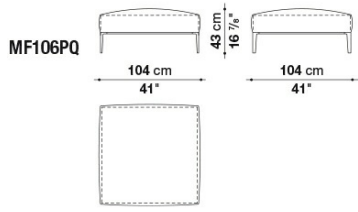

MF106PQ

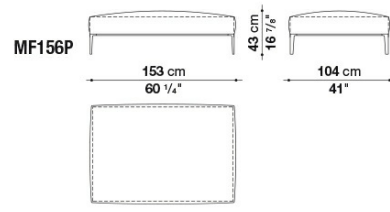

MF156P

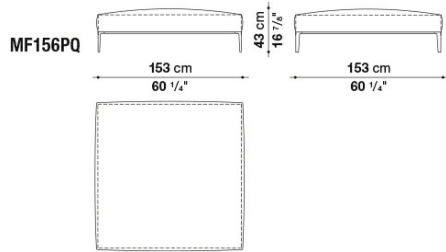

MF156PQ

---

# Compositions

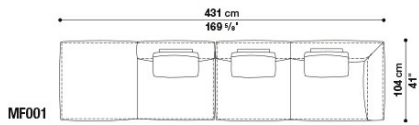

01

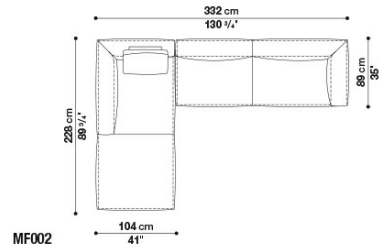

02

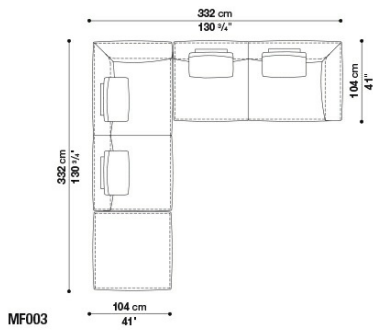

03

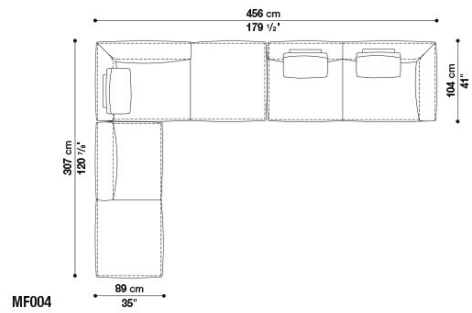

04

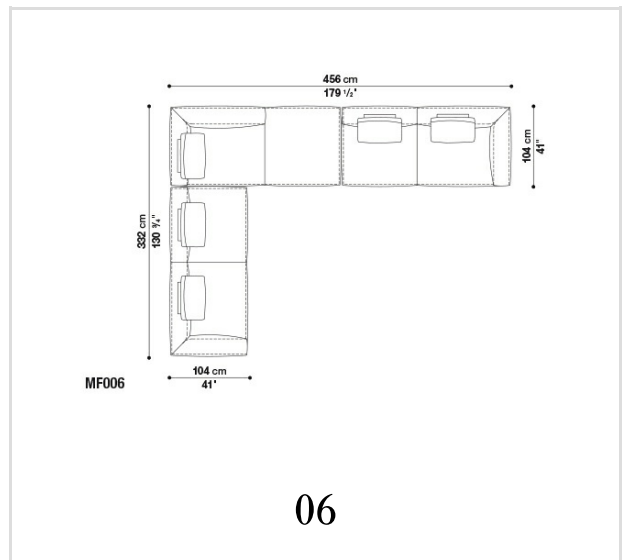
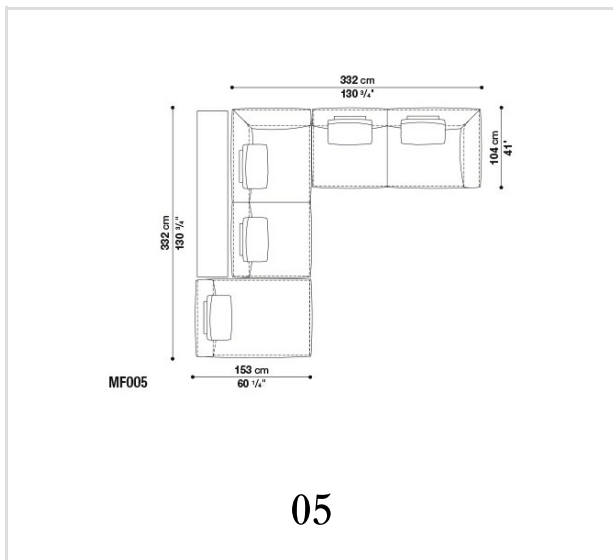

B&B Italia reserves the right to make technological and aesthetic improvements to its models, including changes to the sizes and materials, without notice. The technical drawings do not define the details of the product. The measurements shown are indicative and may undergo changes. In particular, the dimensions relevant to the padded parts are subject to usage tolerances over time caused by the normal adjustment of the padding. For the specific information, please contact the dealer closest to you.